

Modell száma:
2312-320-84

Típus:
320

ESENA

RTV 2D1S

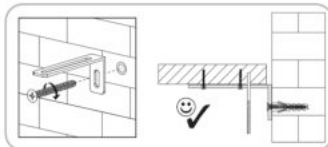
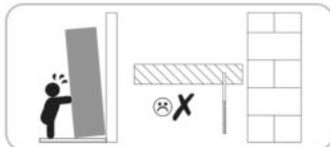
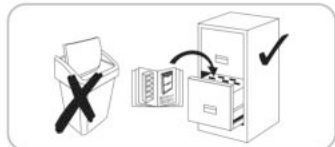
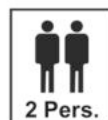
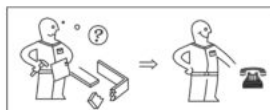
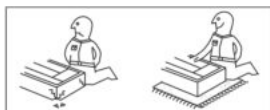
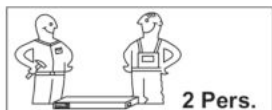

Ø8

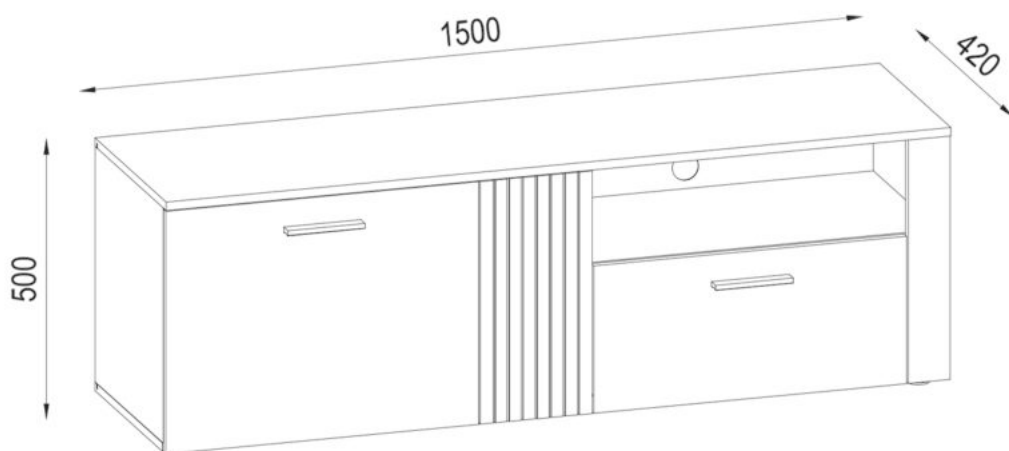

- szorosan meghúzni
- benyomni
- kimérni
- (meg)nyomni
- zatlout
- megfordítani - átfordítani

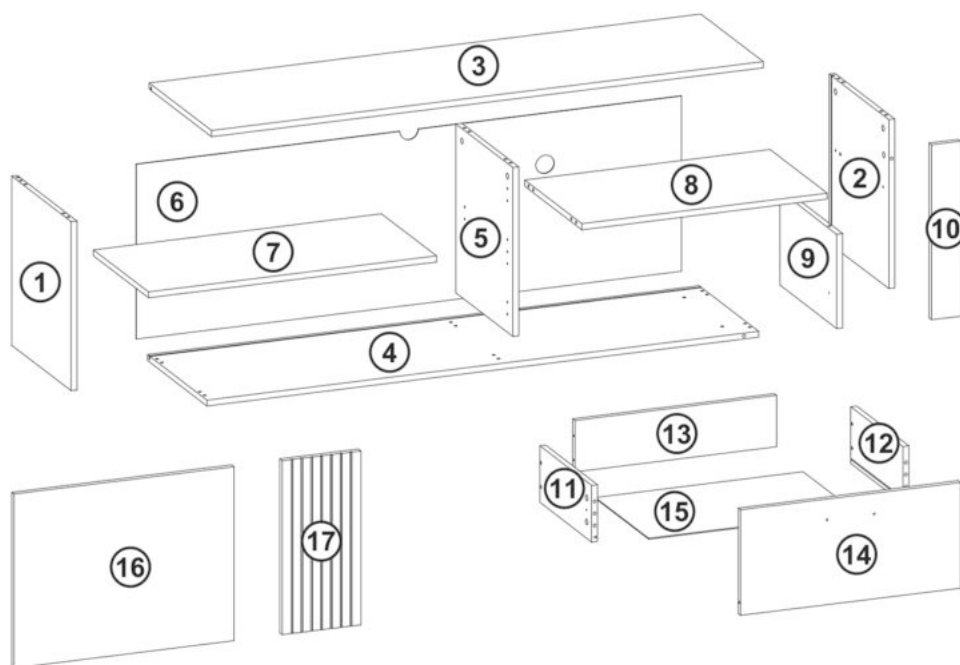







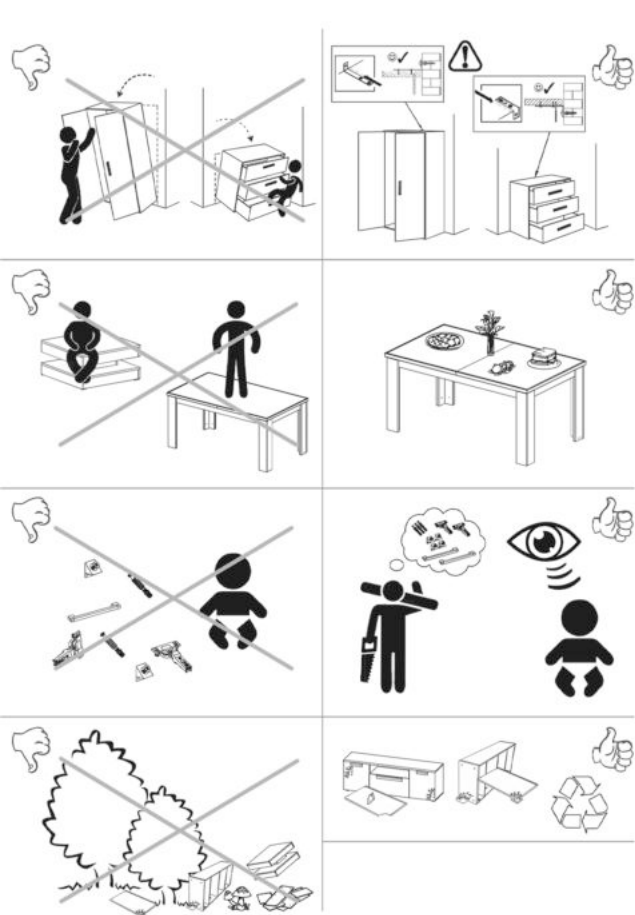





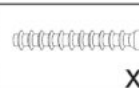

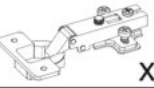





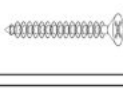

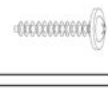

max. 3KG = 15 max. 5KG = 7 8 max. 10KG = 3 4

A	B (mm)		C	D
1	448	400	16	x1 1/2
2	448	400	16	x1 1/2
3	1500	420	16	x1 2/2
4	1500	400	16	x1 2/2
5	448	384	16	x1 1/2
6	464	1482	2,5	x1 2/2
7	783	370	16	x1 2/2
8	667	384	16	x1 2/2
9	250	384	16	x1 1/2

A	B (mm)		C	D
10	464	80	16	x1 2/2
11	350	150	16	x1 1/2
12	350	150	16	x1 1/2
13	548	136	16	x1 2/2
14	598	280	16	x1 2/2
15	564	358	2,5	x1 1/2
16	598	461	16	x1 1/2
17	461	214	16	x1 1/2
B1				1/2

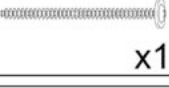

A1 15x12  x16	C2 44mm  x16	B2 8x30  x22
FA1 4mm  x1	F3 6,3x50  x10	O3 Ø18  x6
K6 Ø35  x4	J65 128/148  x2	O4 Ø18  x5
M1 10x10x15  x10	P14 45x20  x5	N1 Ø6  x4
D25 4x25  x5	DA21 4,2x16  x8	DB2 4x25  x4
E5 5x11  x4	D11 3,5x16  x10	D10 3x16  x4
R10 Ø10  x2	I6 350  x1	Y36 75x32x15  x1
	Y37 8x50  x1	Y35 4,2x65  x1
		R6  x1

Tisztelt Ügyfelünk!

Köszönjük, hogy beltéri programunkban szereplő bútor vásárlása mellett döntött, amely kizárólag privát helyiségekben történő használatra készült. Ellenőrizze a szállítmány hiánytalanságát, és figyelmesen olvassa el az alábbi fontos információkat az összeszerelés előtt, valamint tartsa meg ezeket későbbi használat céljából, bárki számára. Bútordarabjainkat rendeltetészerűen kell használni. A nem rendeltetészerű használat dologi károkat vagy bizonyos körülmények között személyi sérüléseket okozhat. A bútor nem játék. A gyártó vagy a kereskedő nem vállal felelősséget olyan károsodásokért, amelyek a nem rendeltetészerű használat vagy a helytelen kezelés miatt keletkeztek.

FIGYELEM: Gyerekek és szellemi fogyatékossgal élő felnőtteket mindig távol kell tartani bútoralkatrészekről, hegyes tárgyaktól, kisméretű alkatrészekről és csomagolóanyagoktól. Sérülés- és fulladásveszély áll fenn. **ÖSSZESZERELÉS:** Összeszereléskor nézze meg az utasításokat az üzemeltetési, kezelési, telepítési vagy szerelési útmutatóinkban, valamint különösen ügyeljen a figyelmeztetésekre és biztonsági utasításokra. Amennyiben nem tartja be az utasításokat, az személyi sérülést vagy bútorkárosodást eredményezhet/biztonsági kockázattá válhat. Amennyiben felépítéskor/összeszereléskor nehézségei vannak, forduljon szervizcsapatunkhoz. Mindig készséggel állnak rendelkezésére. Az összeszerelést csak szakmailag hozzáértő személyek végezhetik el. A termék/termékrészek módosításai esetén, alkatrészek cseréjekor, illetve nema gyártótól/kereskedőtől származó alkatrészek/fogyóanyagok használatakor a károsodásokért nem vállalunk felelősséget. Ha az áruhoz fali rögzítőeszközök, például dübelek és csavarok vannak mellékelve, azok kizárólag erős és egységes anyagú falakon történő alkalmazáshoz valók. A rögzítés csak úgy megfelelő, amennyire a fal és a rögzítőeszköz közötti kapcsolat. Na csak álló, hanem felfüggesztett bútorok esetén is ellenőrizze azok falra rögzítése előtt, hogy azok erre alkalmasak-e, valamint csak ehhez megfelelő rögzítőeszközöket használjon. Esetleges fűrészi munkák esetén bizonyosodjon meg róla, hogy a fűrés területén nincsenek vezetékek. Végezetül a szerelő felelős a falra Ez az történő rögzítésért. Elektromos cikkek, valamint más építészeti tartozékok telepítésére is érvényes. Az elektromos cikkek, valamint más, építészethez kapcsolódó tartozékok összeszerelését/telepítését csak arra feljogosított szakemberek végezheti. Minden elektromos és építészeti telepítést az Önök országában hatályos vonatkozó szabványok, illetve biztonsági előírások szerint kell elvégezni. Fényfűrészek esetén csak megengedett izzóerősségeket állítson be. A maximális teljesítmény ne tartása esetén a túlmelegedés miatt tűzveszély áll fenn. A tűzveszély miatt az izzót tilos letakarni.

A bútor kifogástalan működőképessége csak függőleges és vízszintes feldíllítása esetén biztosított. Az ajtók előzetesen be vannak állítva, de szükség esetén a helyi körülményeknek megfelelően újra beállíthatók/beigazíthatók. Feltétlenül tartsa be a maximális terhelésre vonatkozó súlyadatokat. A bútorokra tilos felmászni. Szakszerűtlen kezelés esetén a bútordarabok felborulhatnak. Ennek megelőzése érdekében a bútorokat mindig biztosítani kell felborulás ellen. Túlterhelés/túlzott igénybevétel esetén (különösen játszó gyerekek, emberek, anyag vagy egyéb szakszerűtlen behatások miatt) törés- és sérülésveszély áll fenn. Minden csavaron, valamint teherhordó kapcsolódási helyen 5-6 hétig utánhúzdást kell végezni, a tartósan biztos rögzítés biztosítása céljából.

ÁPOLÁS: -Bútorápolási utasítások- Vegye figyelembe a helyes bútorápolásra vonatkozó utasításainkat, hogy a lehető leghosszabb ideig örömet lelje termékünkben.

Tisztításkor tiszta, száraz, puha pamutkendőt használjon. Ha bútorra alaposabb tisztítást igényel, akkor a kendőt kevés vízzel vagy bútorápoló szerrel megnedvesítheti, végül a megtisztított elemeket szárítsa meg. A fém- és üvegalkatrészeket a legjobb, ha kereskedelmi forgalomban kapható fém- és üveg tisztítóval, a rajtuk szereplő ápolási útmutatásoknak megfelelően tisztítja. A tisztítószerek rendelkeznie kell egyértelmű utalással arra vonatkozóan, hogy a szer bútorápolásra megfelelő. Semmilyen körülmények között se használjon gőzölős tisztítót, se maró, dörzsölő hatású, vagy egyéb olyan szert, amelynek nem ismeri a hatását.

FIGYELEM: A magasfényű felületeket kiszállításkor védőfólia óvja. Ezeket addig hagyja rajta a bútoron, amíg azt teljesen össze nem szerelik, és nem portalanítyák. A magasfényű elemeket, amelyekről eltávolították a védőfóliát, csak 72 óra elteltével (a helyiség levegőjén történő utólagos keményedés ideje) szabad tisztítani vagy használni.

Ne sértse meg a felületeket éles tárgyakkal, és soha ne tegye ki erős napsugárzásnak.

HULLADÉKKEZELÉS: Hulladékkezelésre vonatkozó tudnivalók A környezet védelme céljából a csomagolási hulladékot fajta szerint szétválogatva tegye az arra szolgáló hulladékgyűjtőbe/újrahasznosító konténerbe, ne a természetbe dobja. A sérült vagy használhatatlan bútort arra kijelölt újrahasznosító létesítményben adja le, ahol az egyes alkatrészeit újrahasznosítják. A leselejtezett, de még használható bútorokat nem kell azonnal a hulladékba kidobni. Adományként leadhatja pl. jótékonyági szervezeteknél.

Új bútorához sok örömet kívánunk!

1

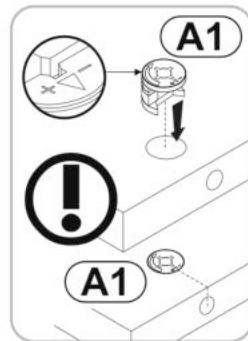
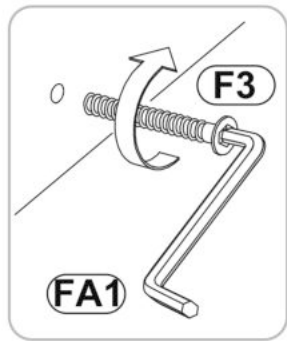
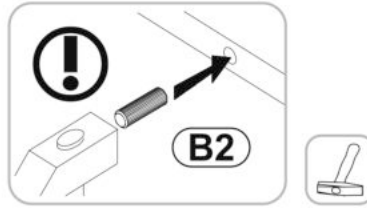
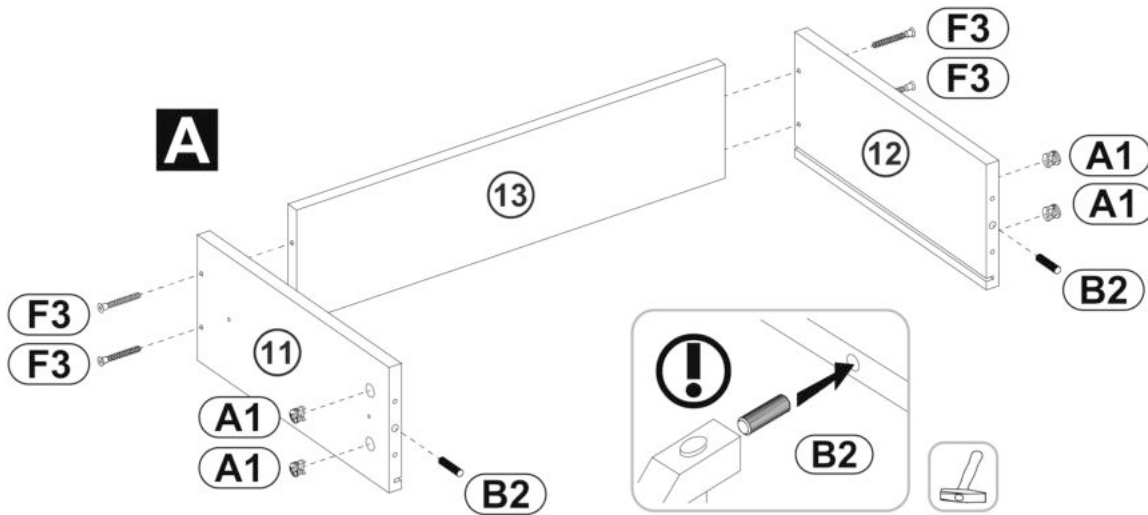
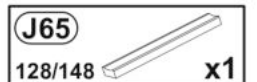
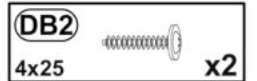
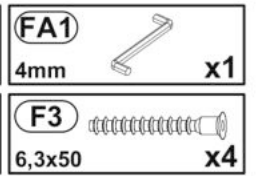
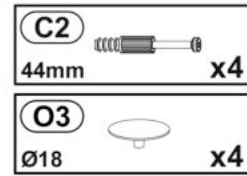
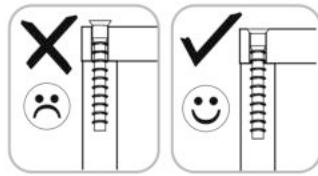
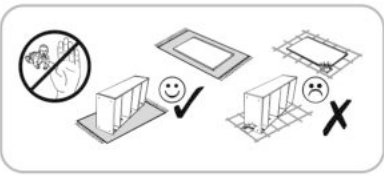

B

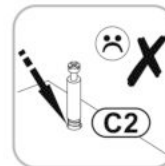
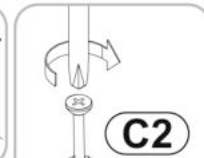
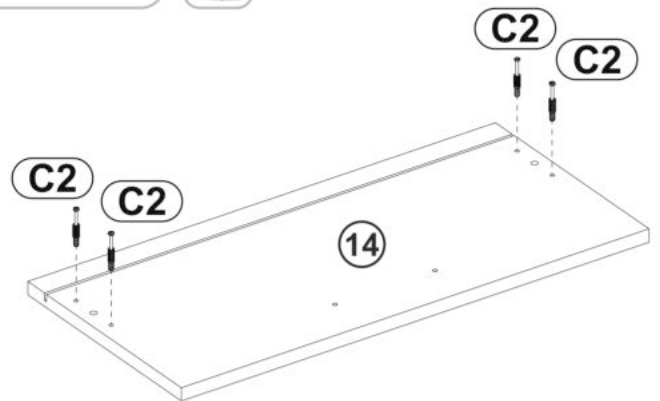

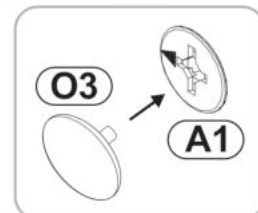
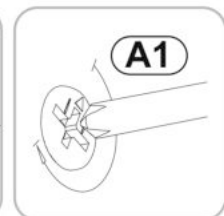
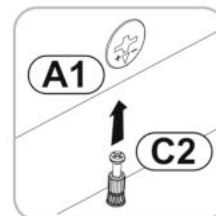
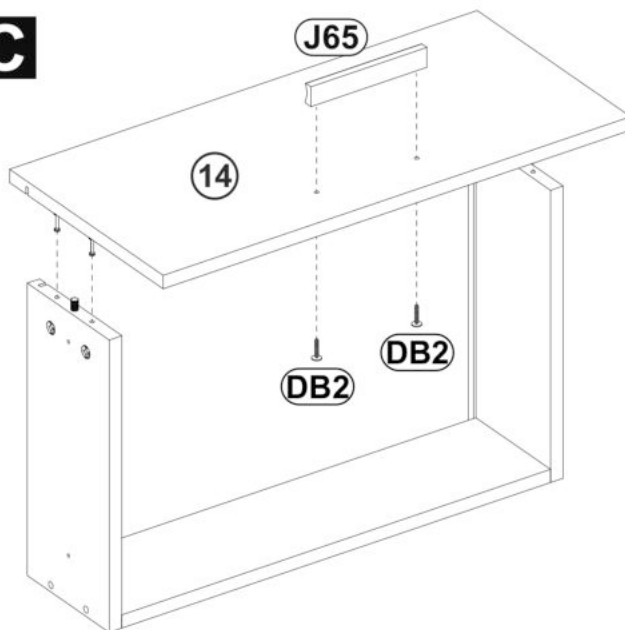

C

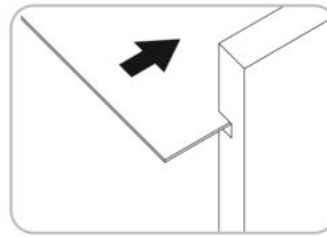
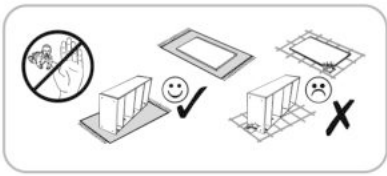

2



DA21 4,2x16		x4
I6 350		x1
D10 3,0x16		x4

D

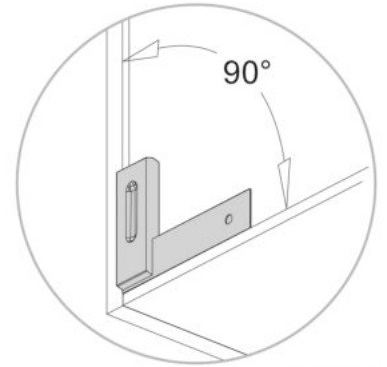
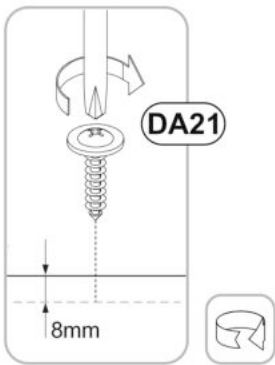
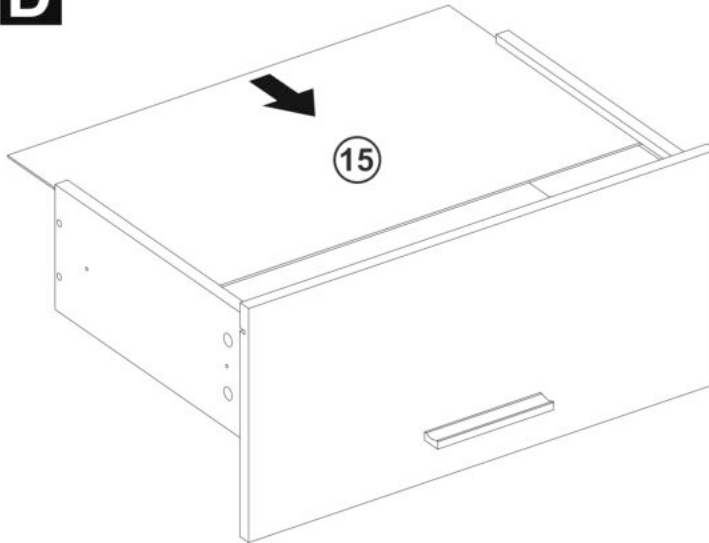

A=B

E

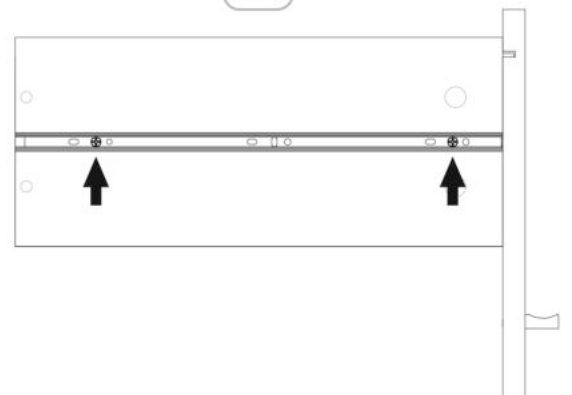
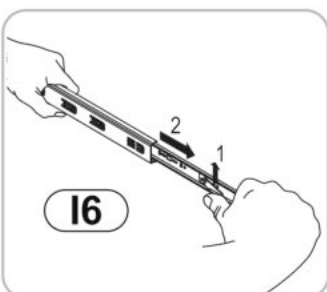
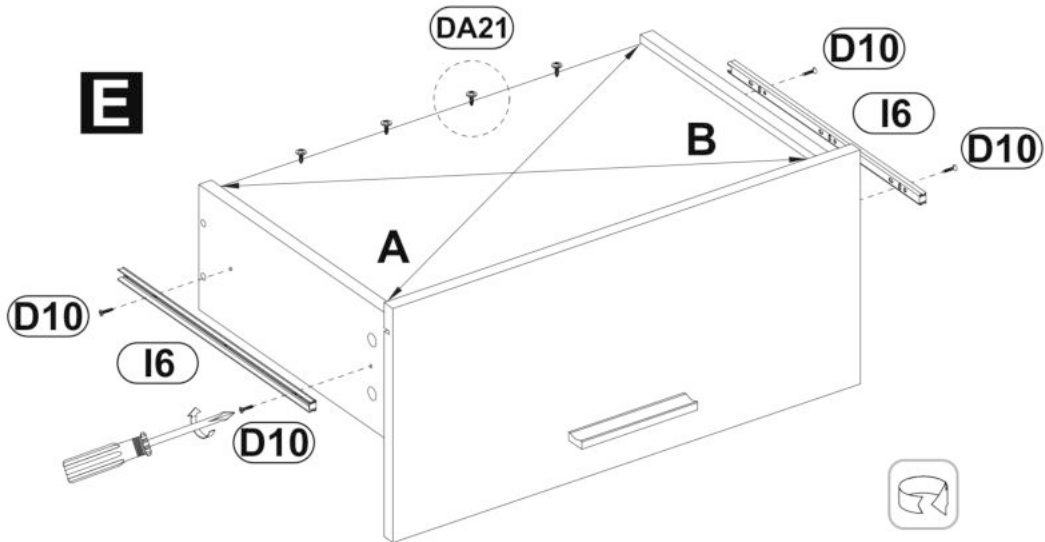

3

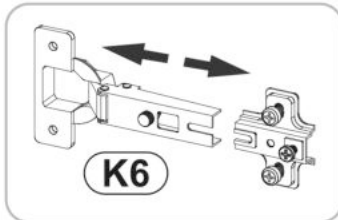
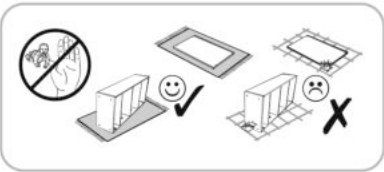

A1
15x12 x9

B2
8x30 x12

K6
Ø35 x2

C2
44mm x2

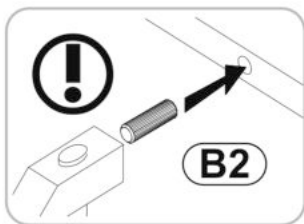
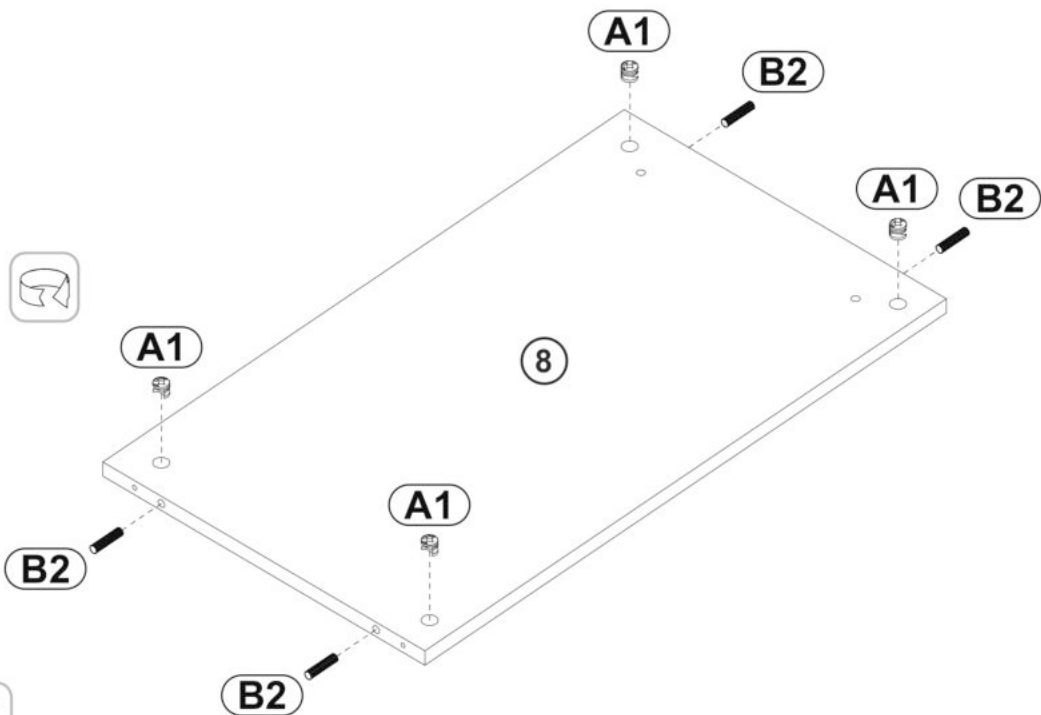
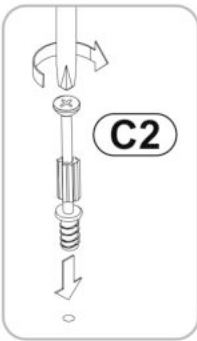
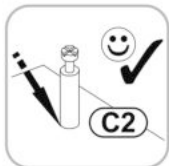
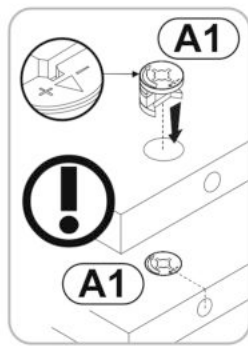
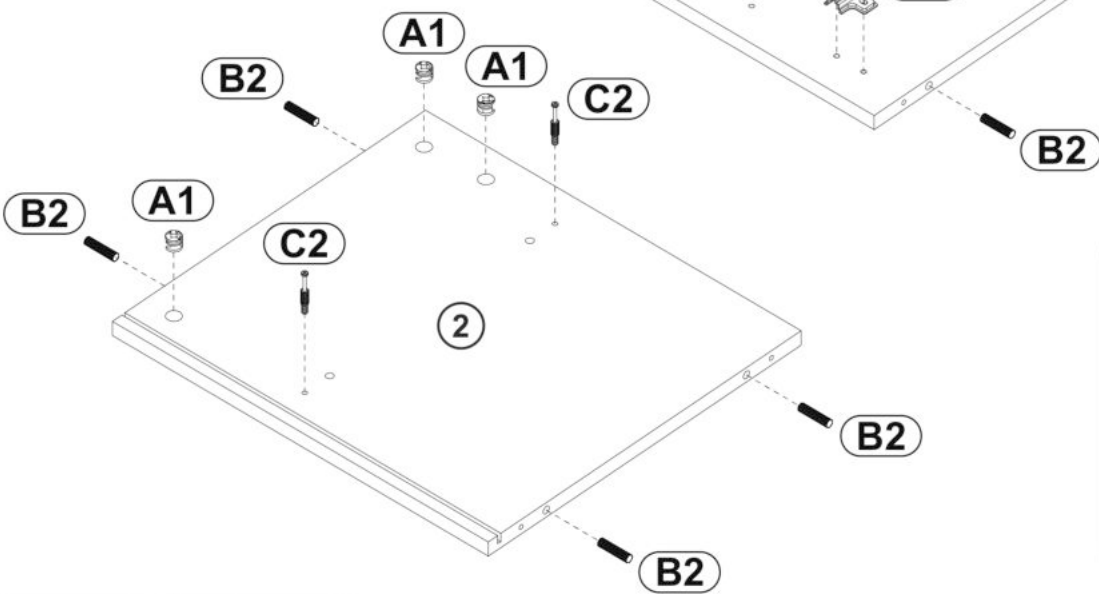
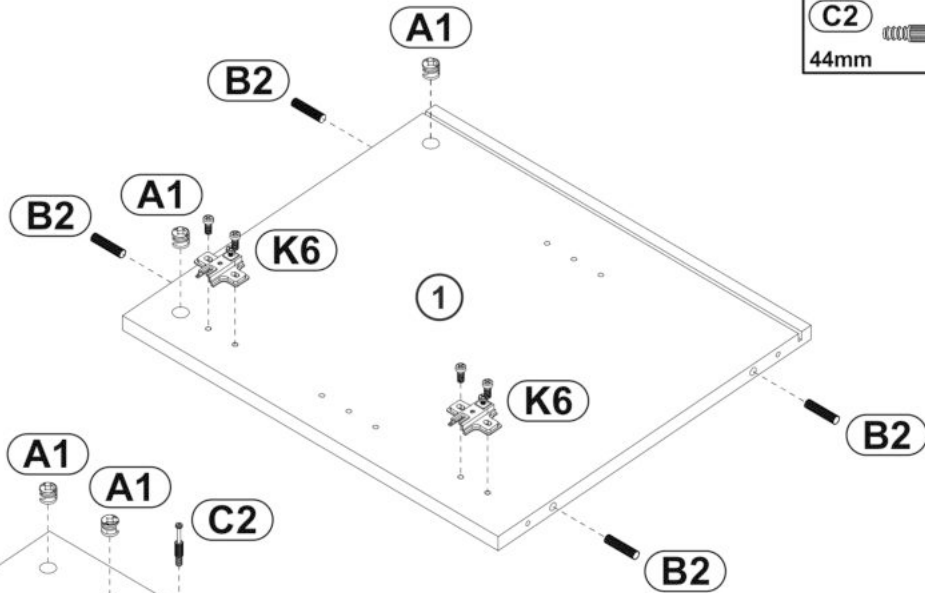
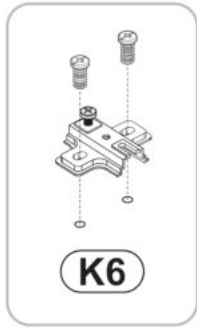

4

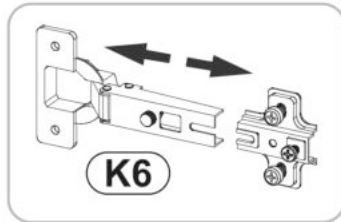
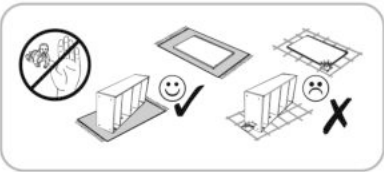

- A1** 15x12 x2
- C2** 44mm x2
- B2** 8x30 x8
- K6** Ø35 x2
- I6** 350 x1
- E5** 5x11 x4

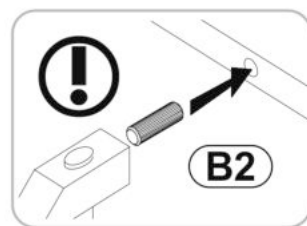
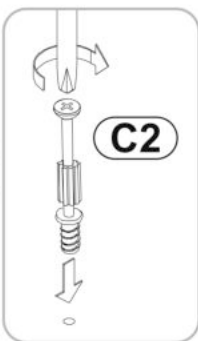
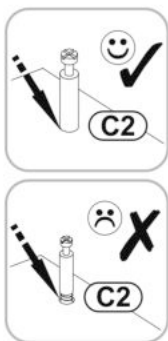
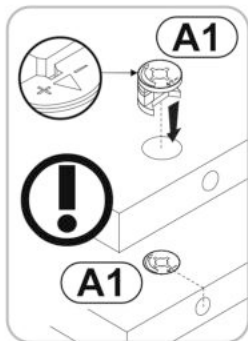
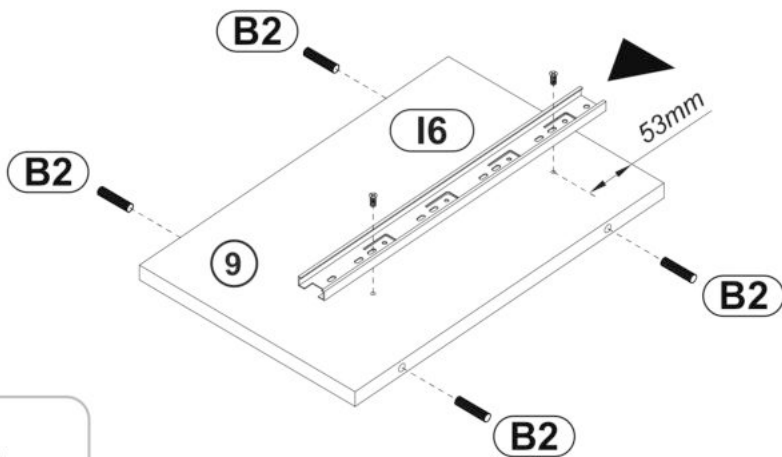
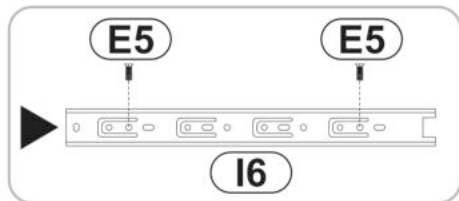
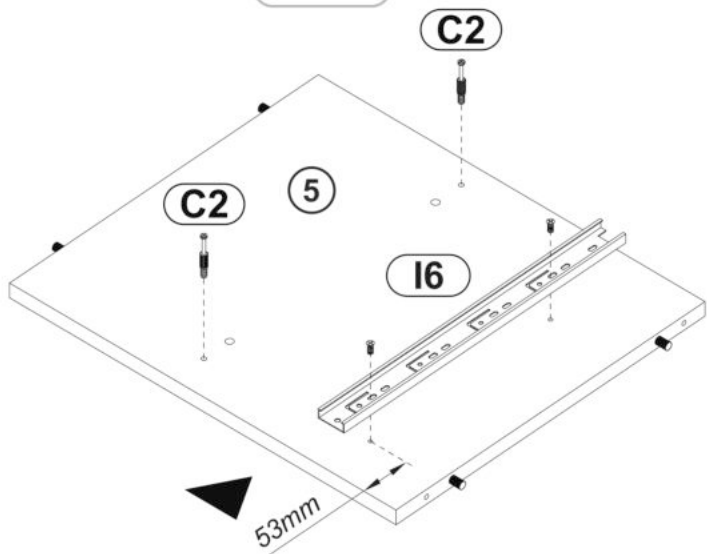
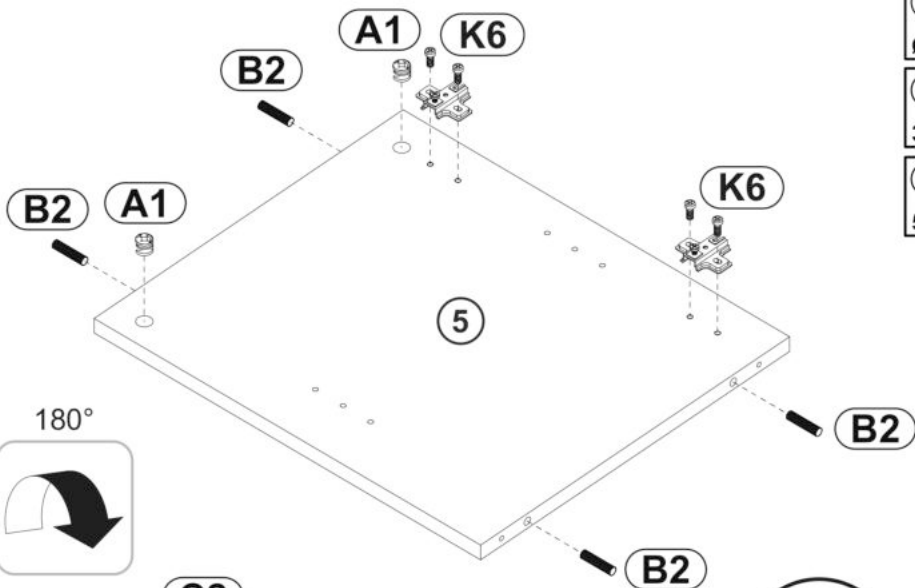
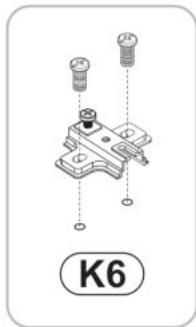

5

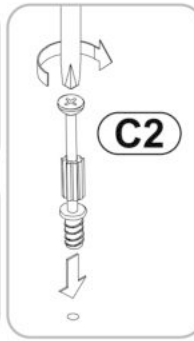
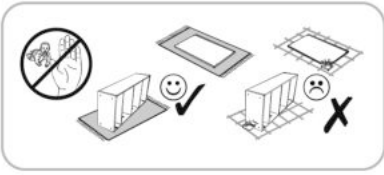

C2		x8
44mm		
A1		x1
15x12		
Y36		x1
75x32x15		
D11		x2
3,5x16		

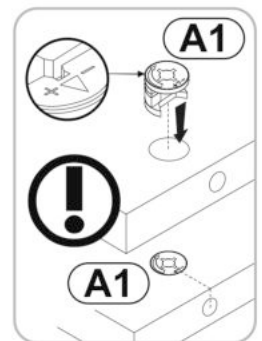
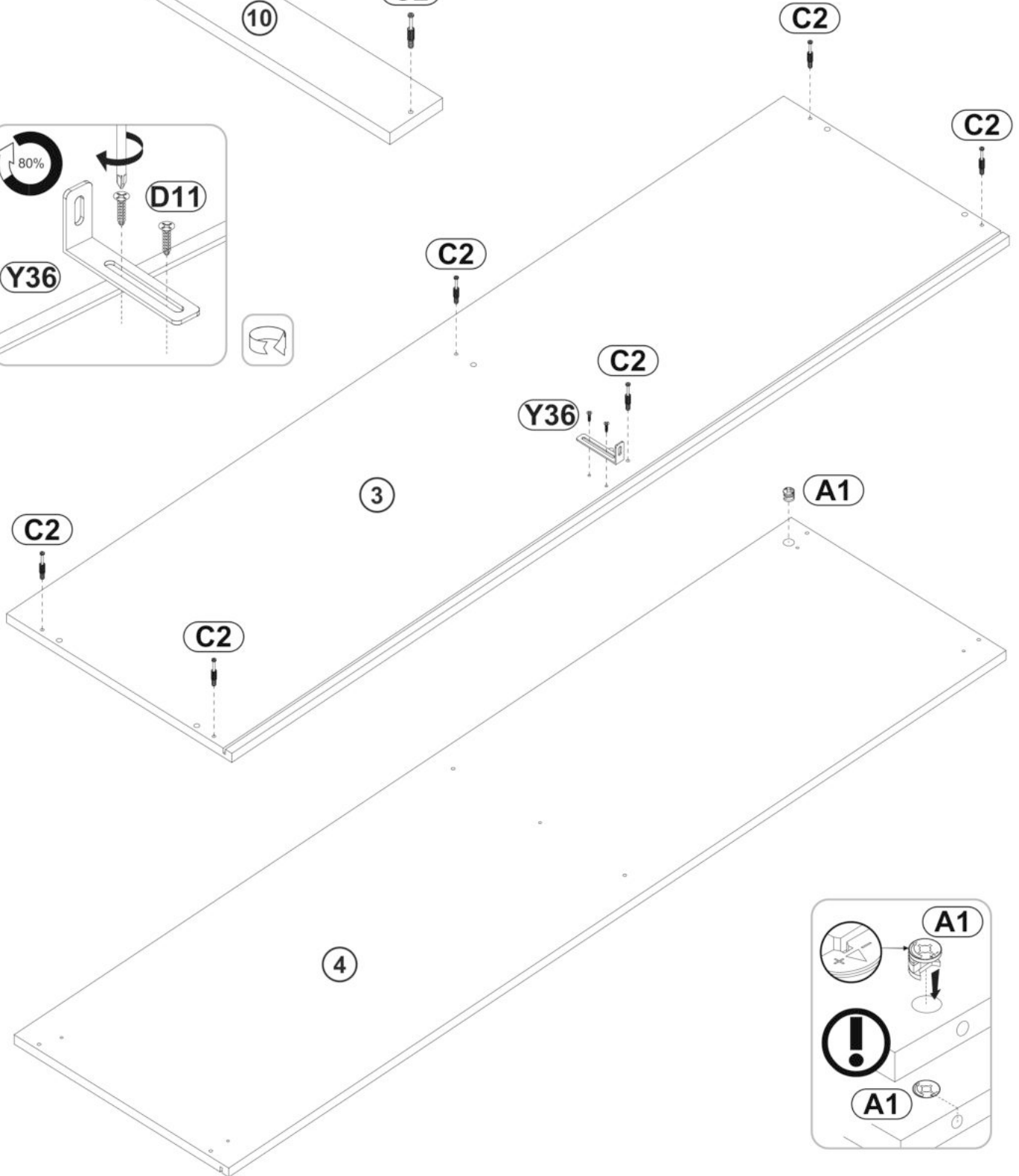
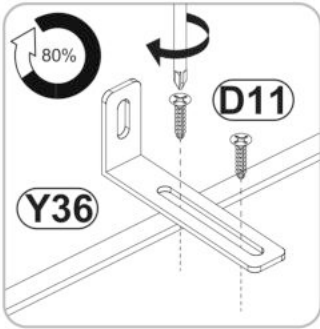
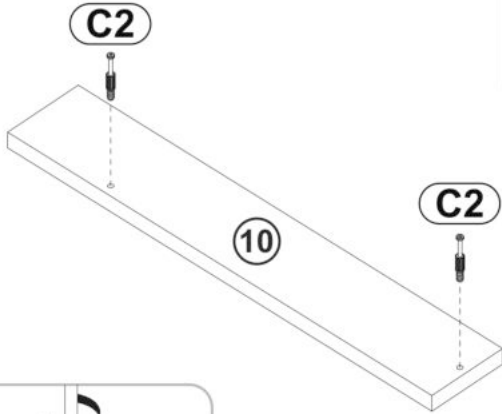

6

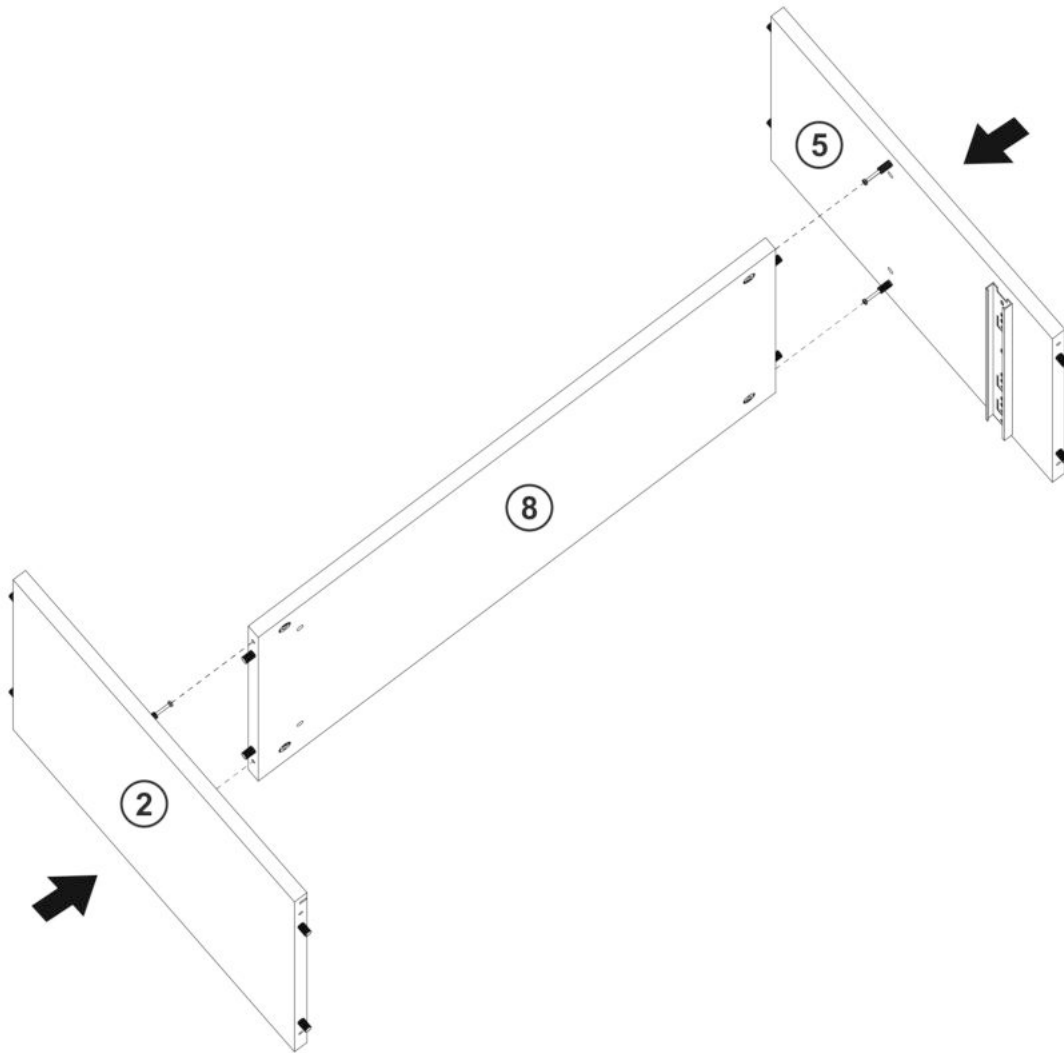
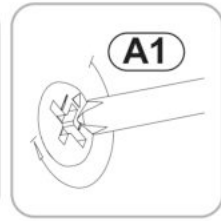
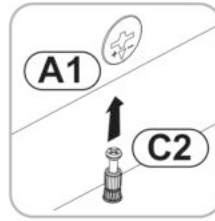
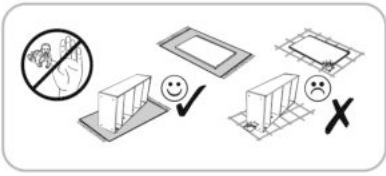

7

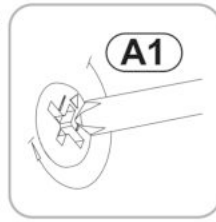
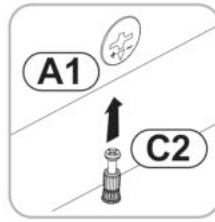
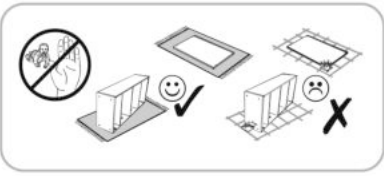

O4  **x4**
Ø18

O3  **x2**
Ø18

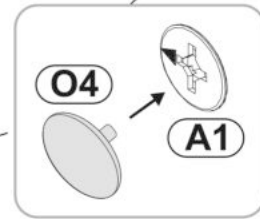
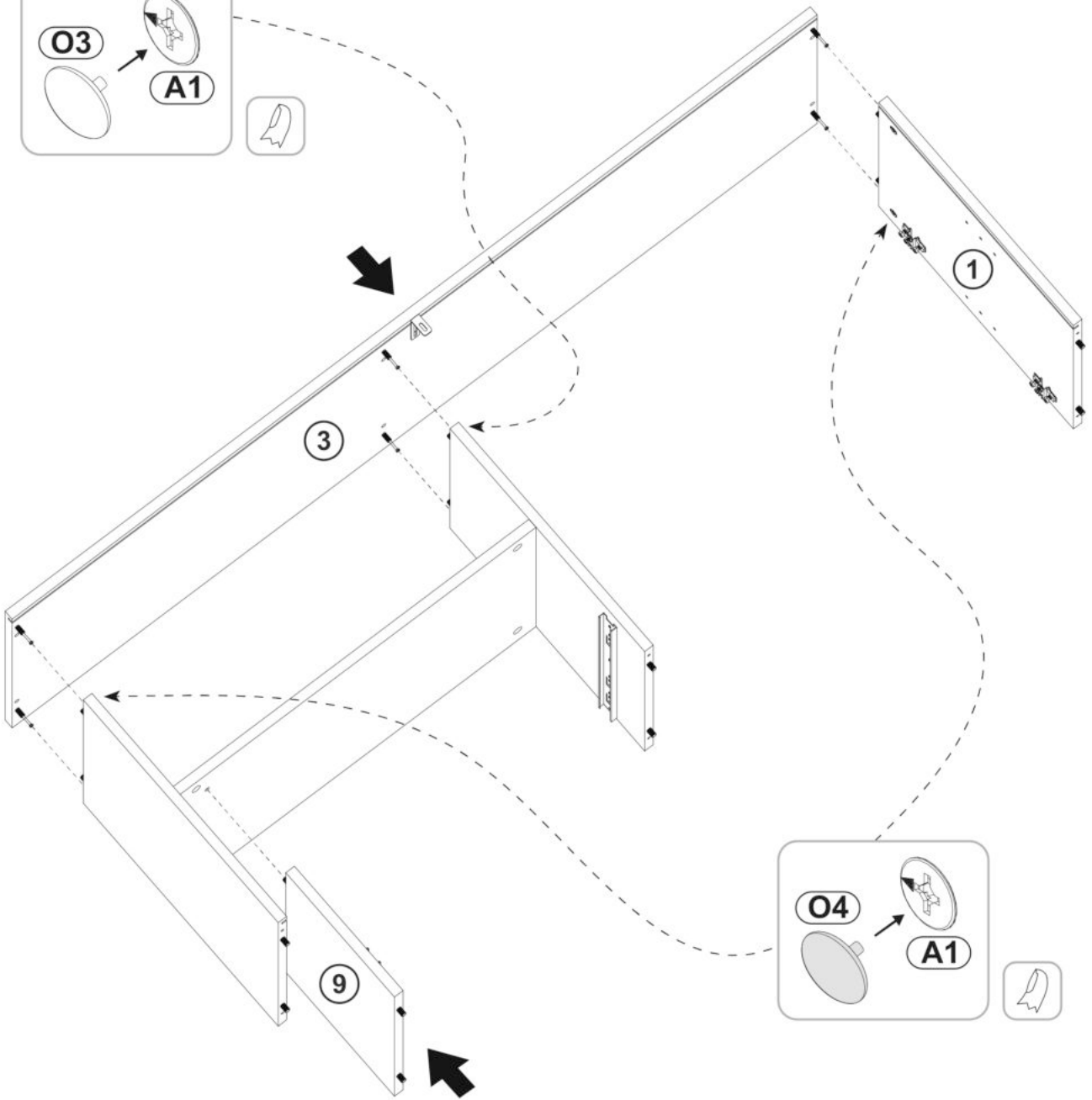
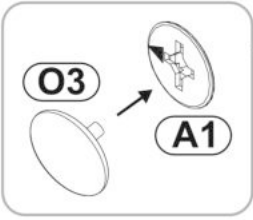

8

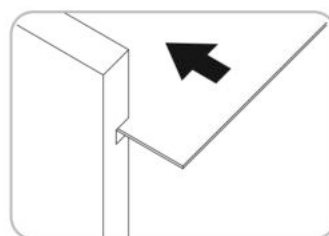
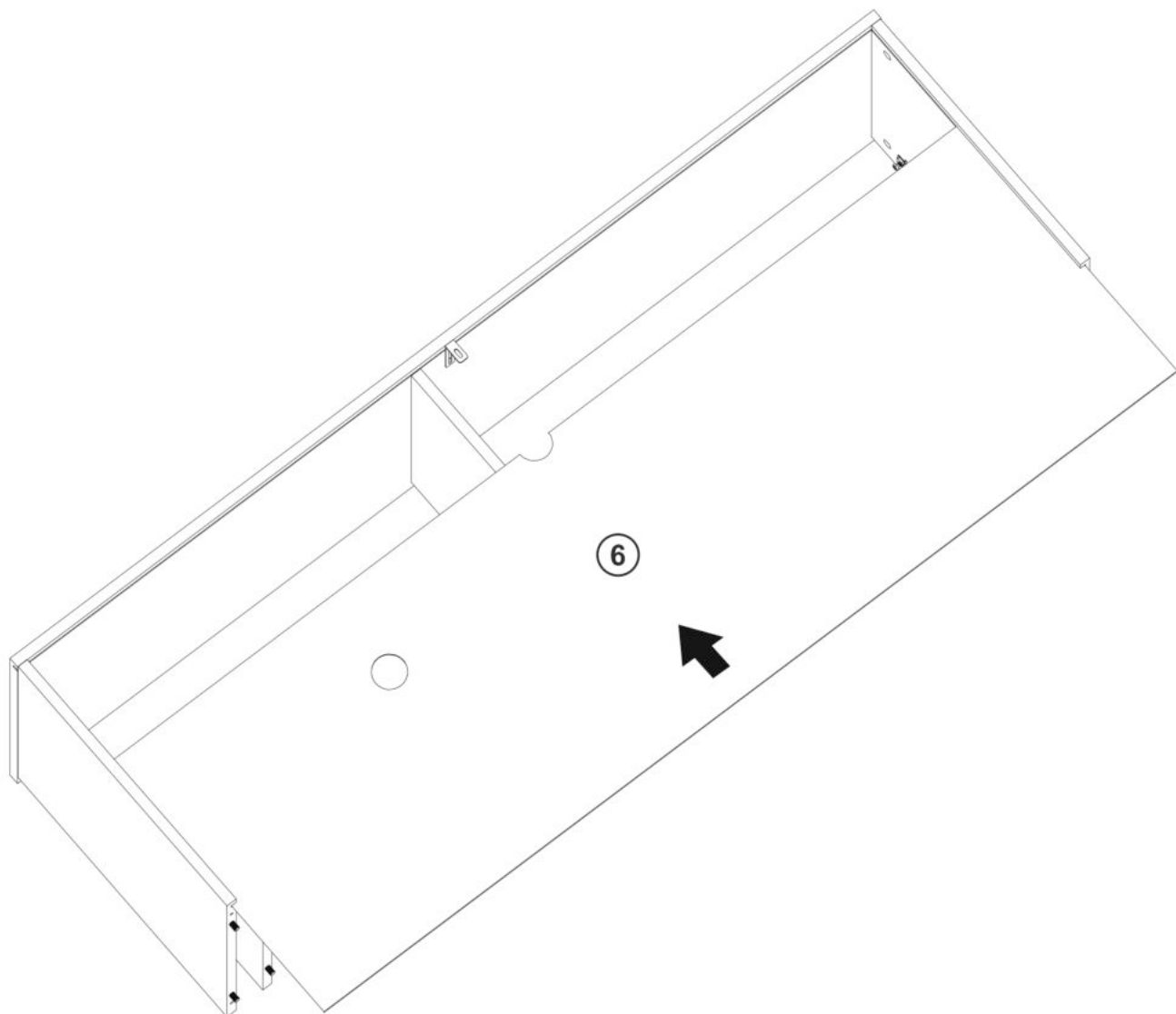
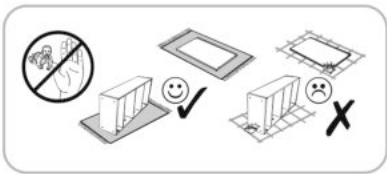

9

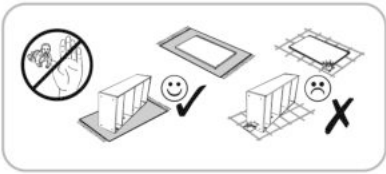

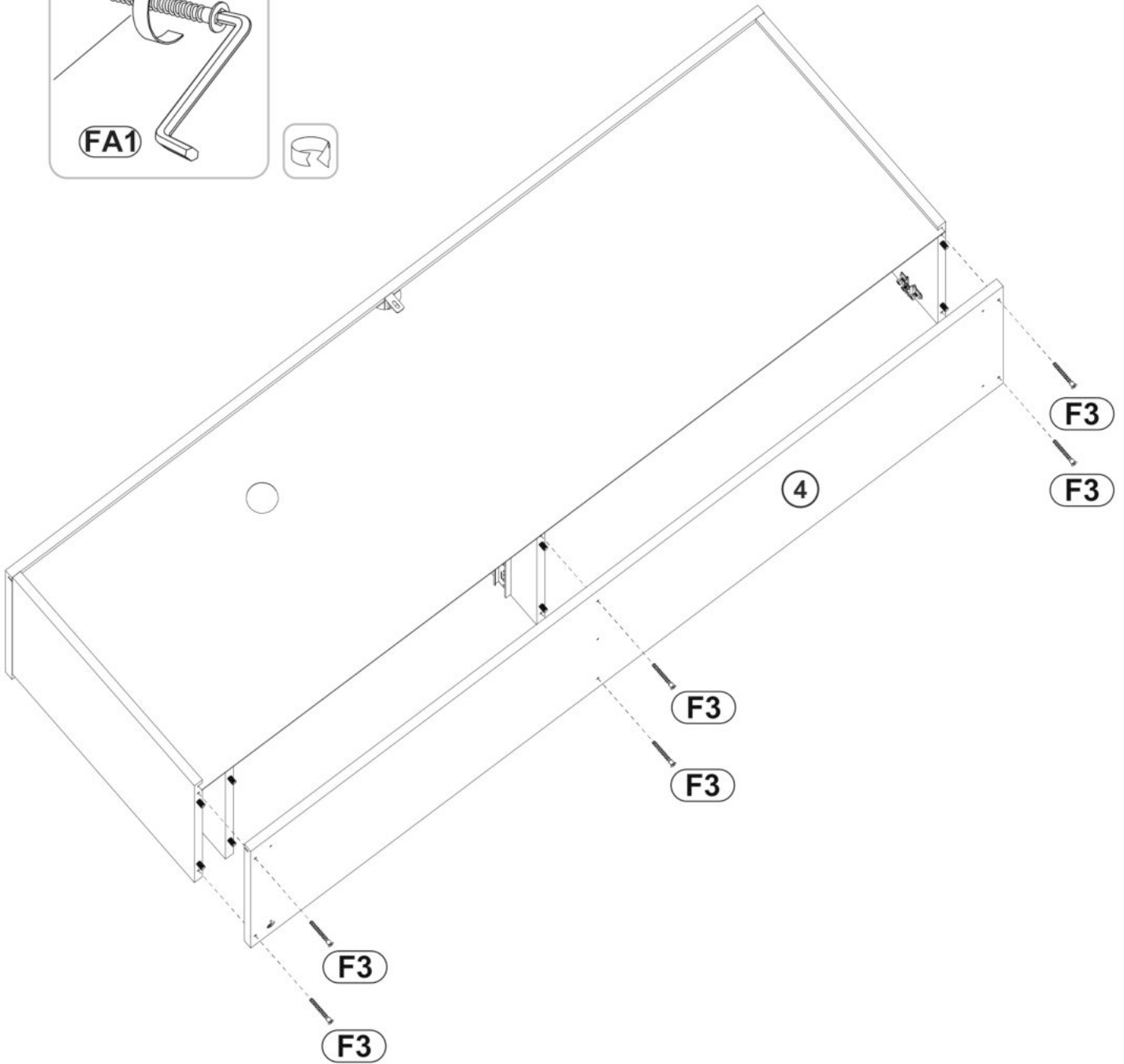
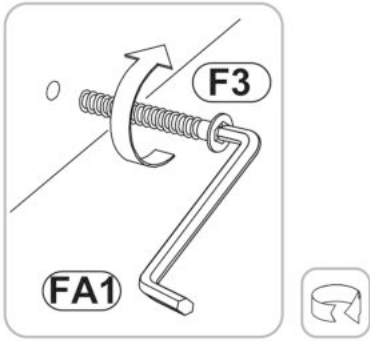

FA1
4mm x1

F3
6,3x50 x6

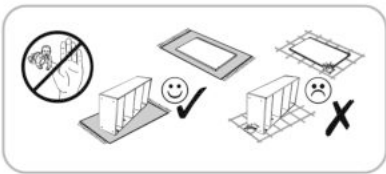

10



O4  **x1**
Ø18

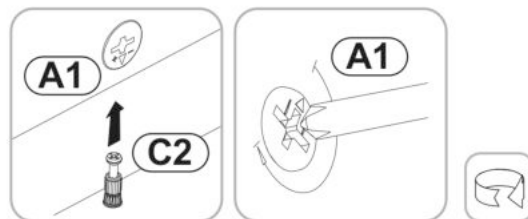
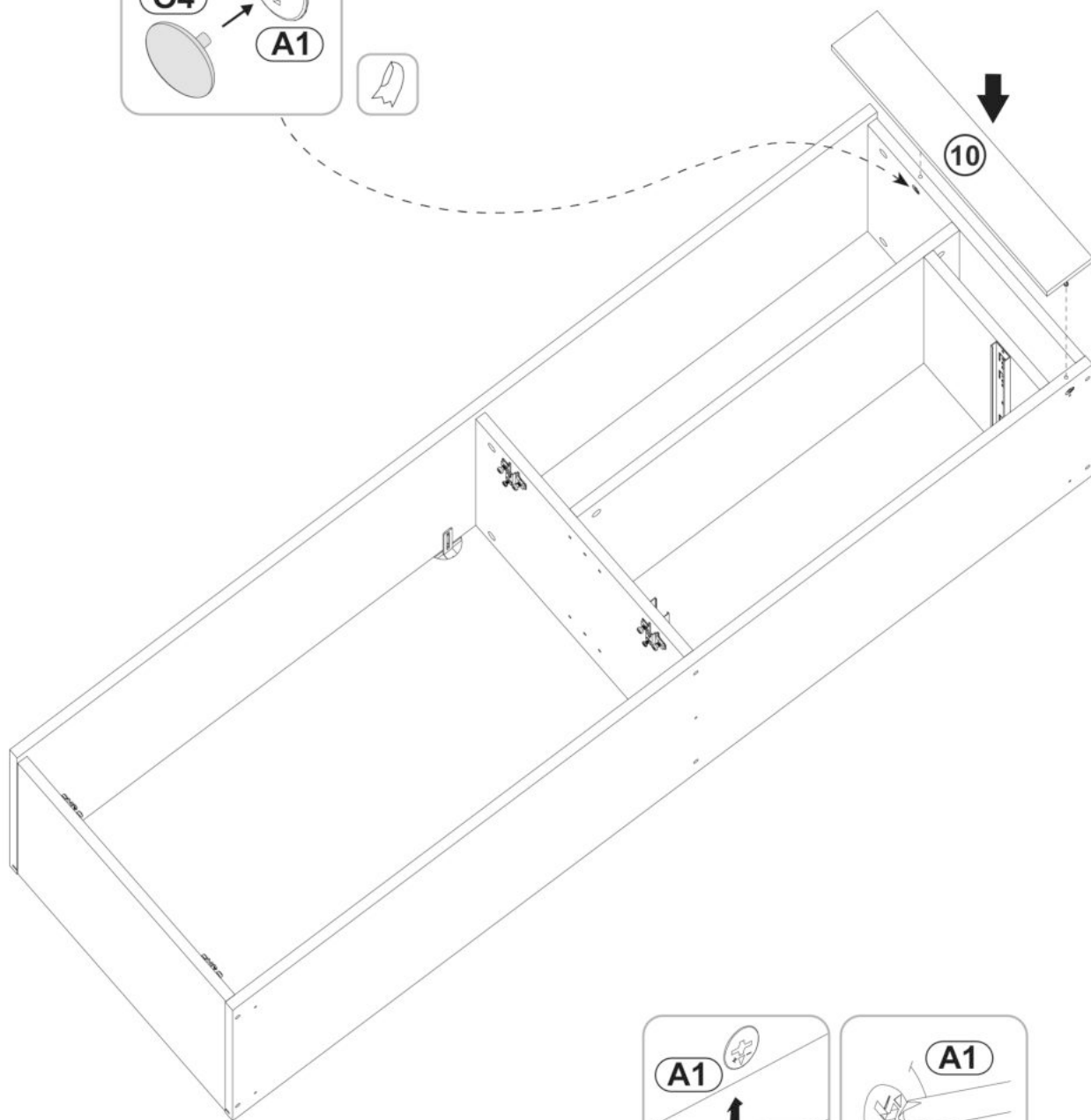
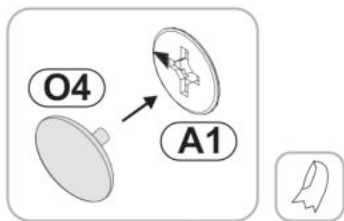

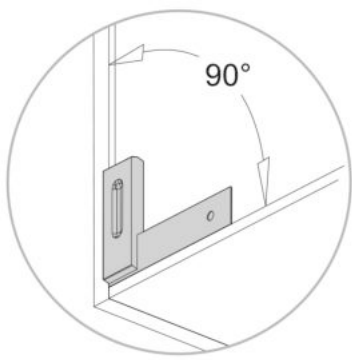
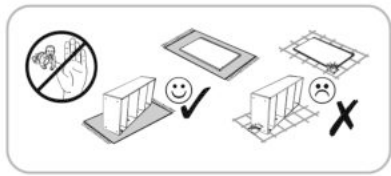

- M1**
10x10x15 x10
- DA21**
4,2x16 x4
- P14**
45x20 x5
- D25**
4x25 x5

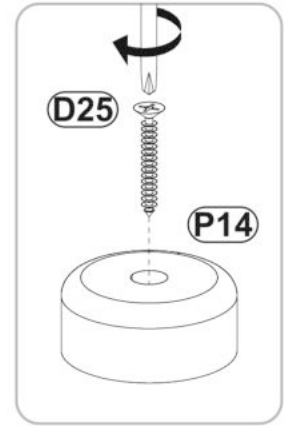
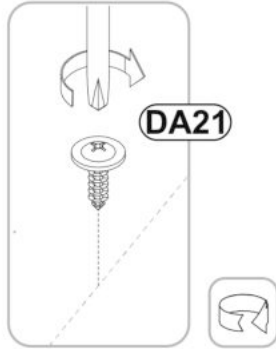
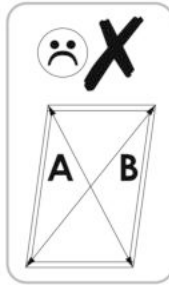
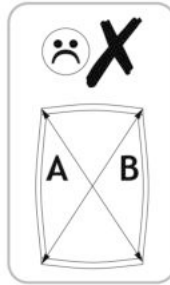
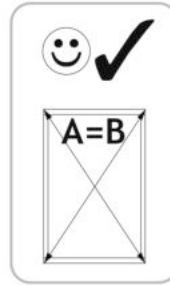
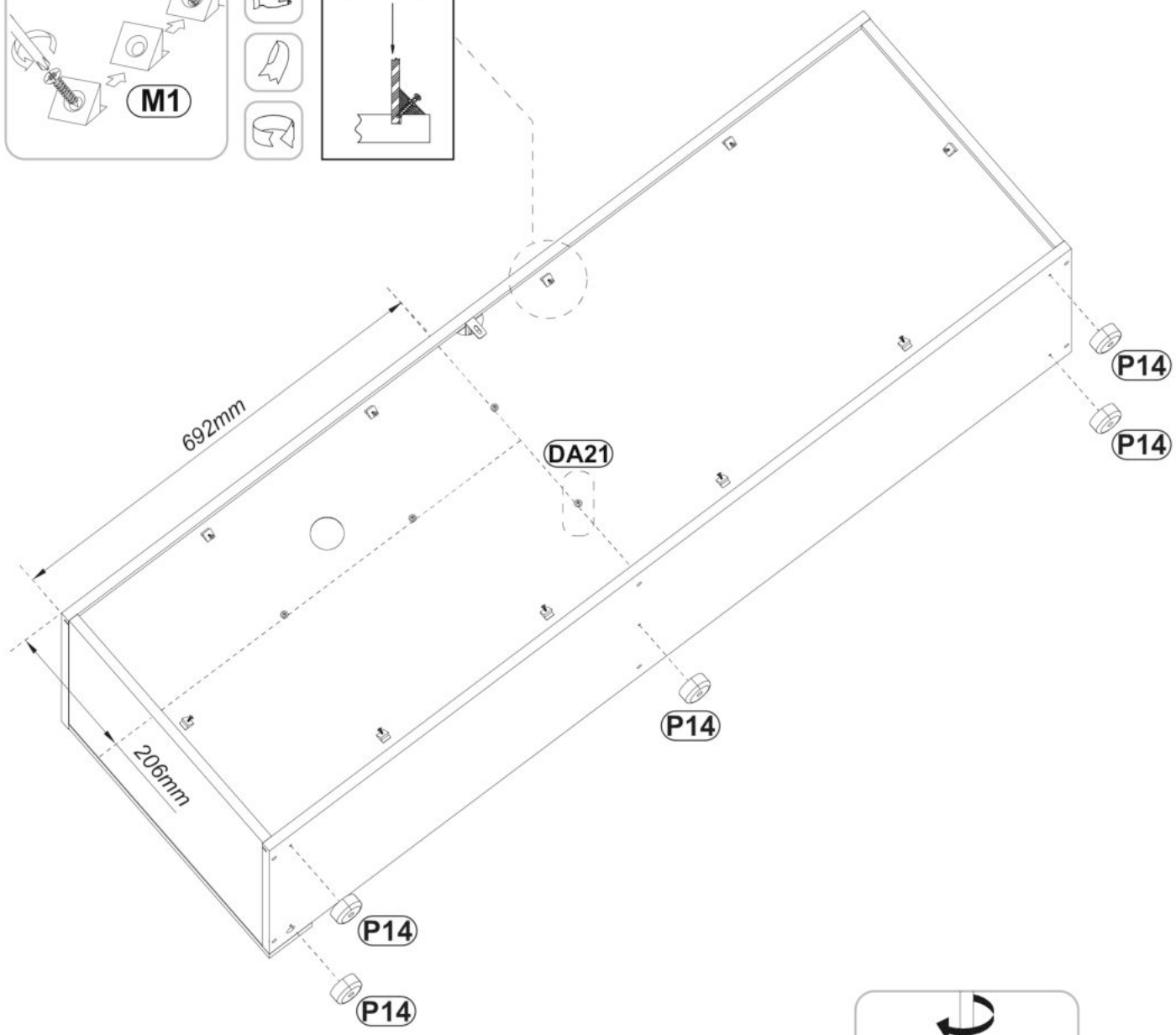
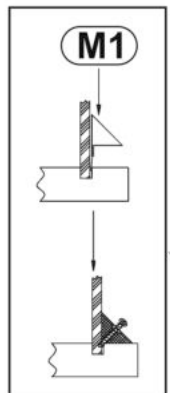
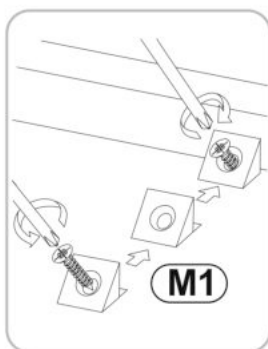

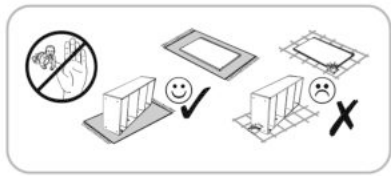

- (N1)** x4
- (Y37)** x1
- (Y35)** x1

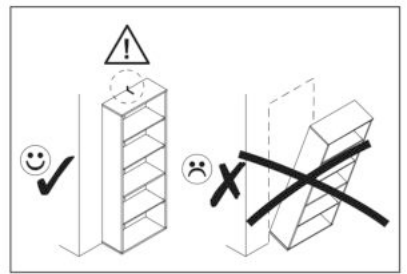
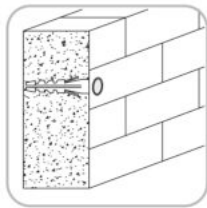
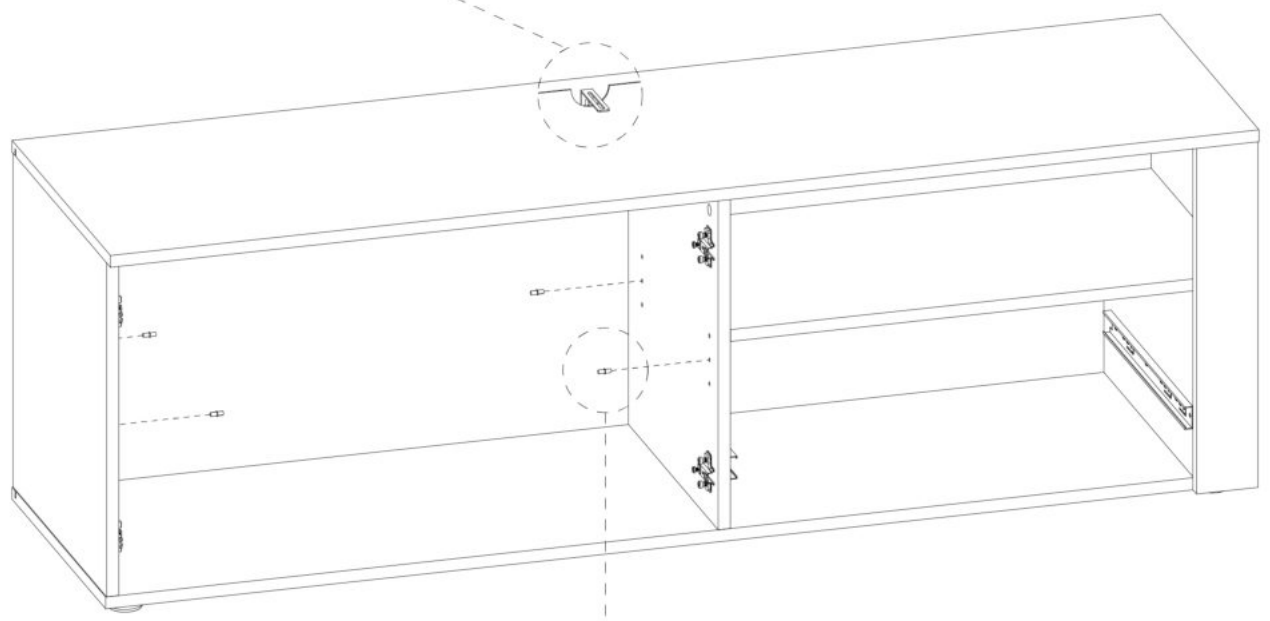
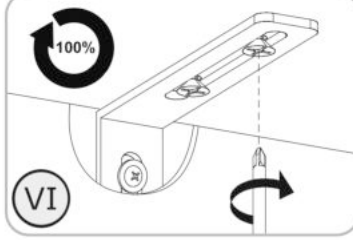
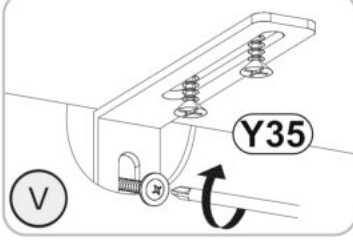
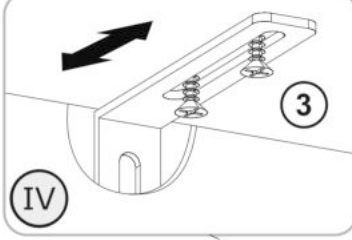
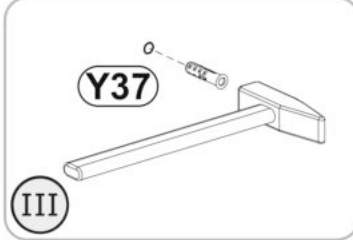
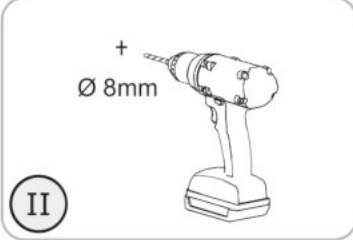
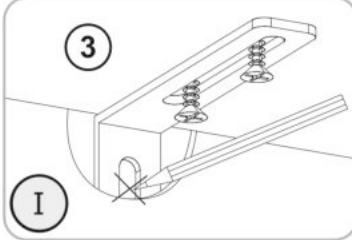

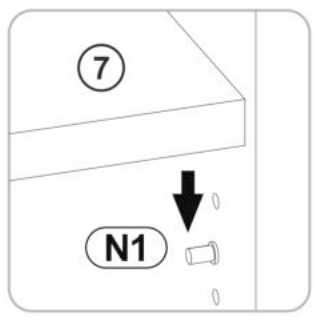
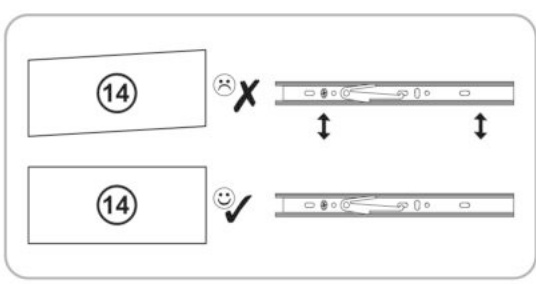
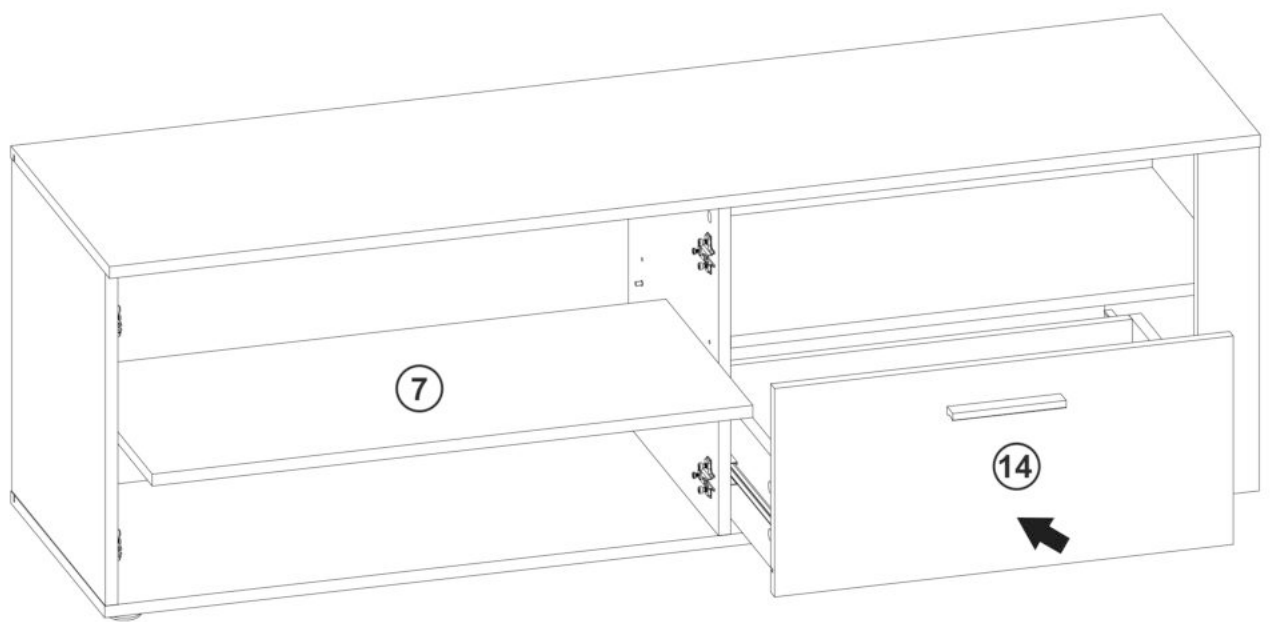
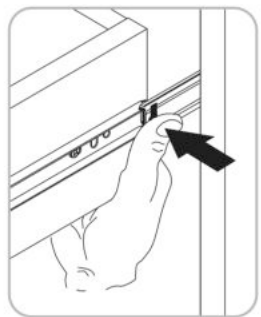
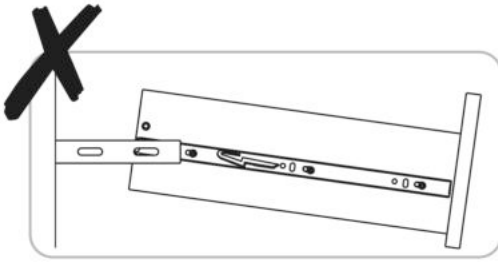
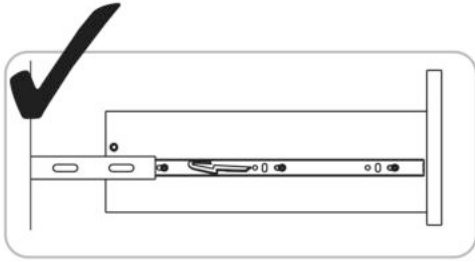
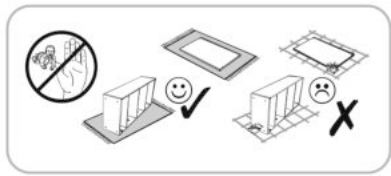

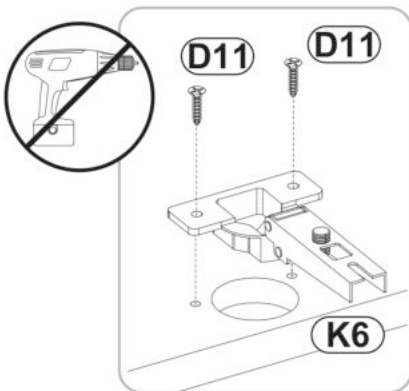
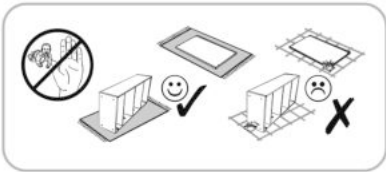

K6
Ø35 x4

D11
3,5x16 x8

DB2
4x25 x2

J65
128/148 x1

R10
Ø10 x2

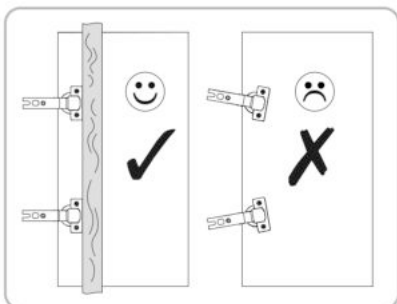
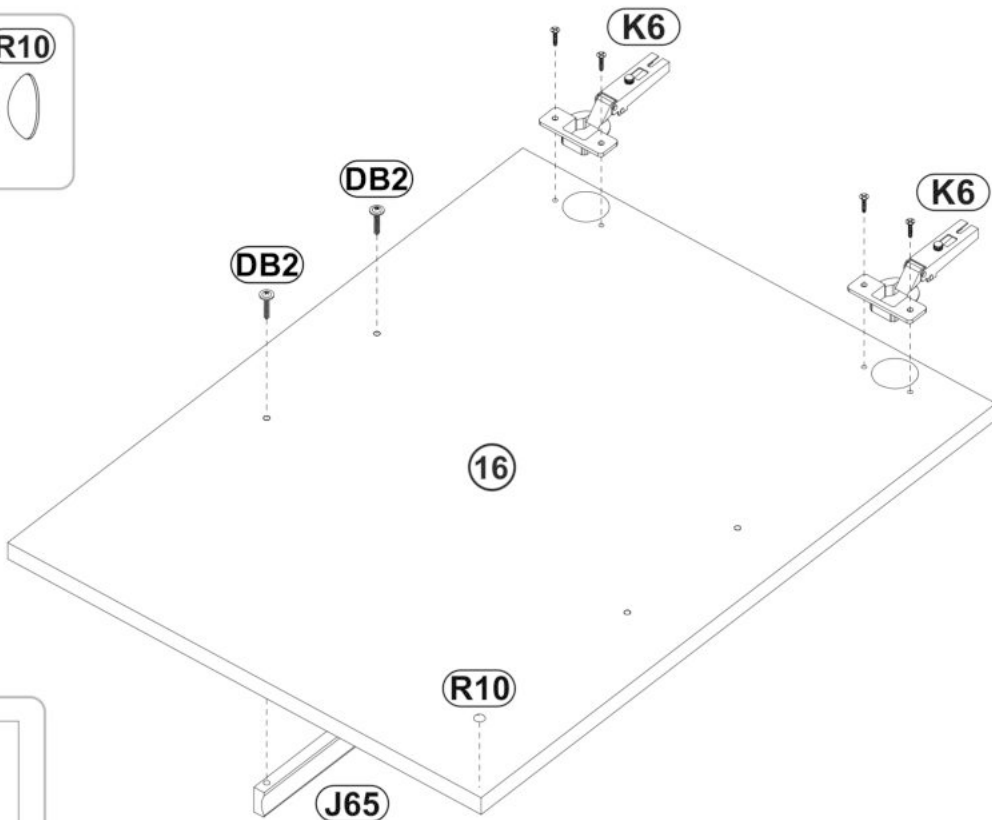
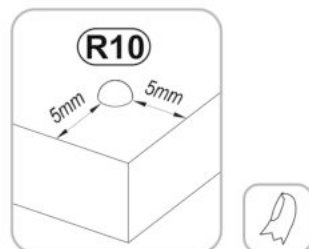
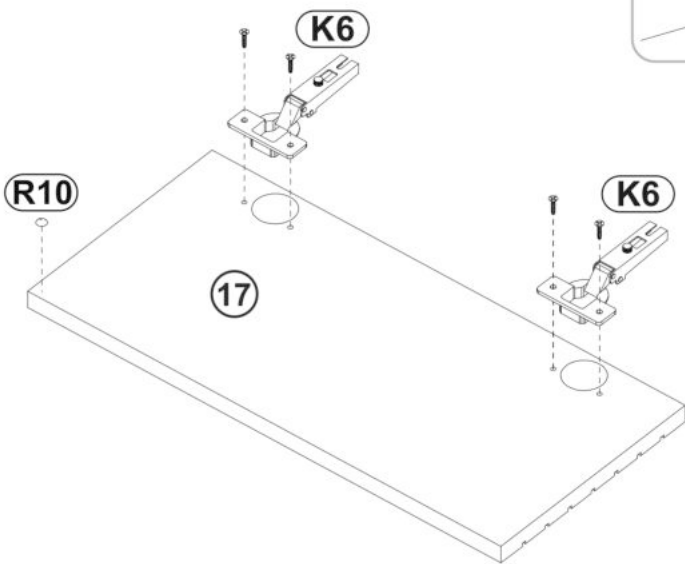

15

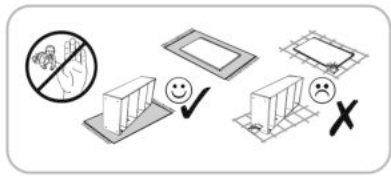

R6  x1

